

*heuristic* (adj)

- involving or serving as an aid to learning, discovery, or problem-solving by experimental and especially trial-and-error methods;
- of or relating to exploratory problem-solving techniques that utilize self-educating techniques (as the evaluation of feedback) to improve performance

*heuristic* (noun)

- the study or practice of heuristic procedure
- a heuristic method or procedure

[www.merriam-webster.com](http://www.merriam-webster.com)

For some problems, you can get to a solution by:

- Solving a simpler form (wishful thinking: that the problem were simpler)
- Modifying the solution for the simpler form to become a solution for the original form

# Wishful Thinking Example

Draw a continuous line connecting each pair of boxes that have the same label.

The lines cannot go outside the large box, go through the small boxes, and they cannot cross.

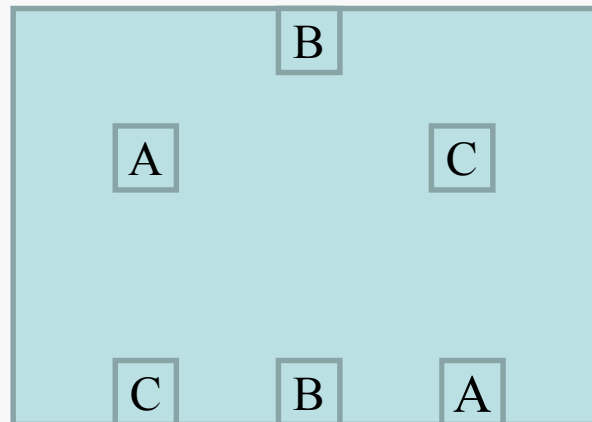

# Wishful Thinking Example

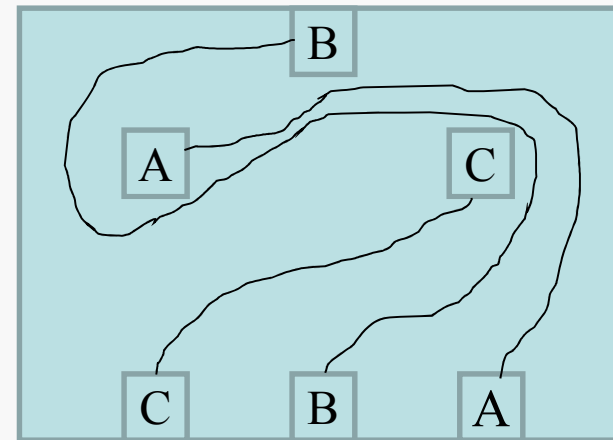
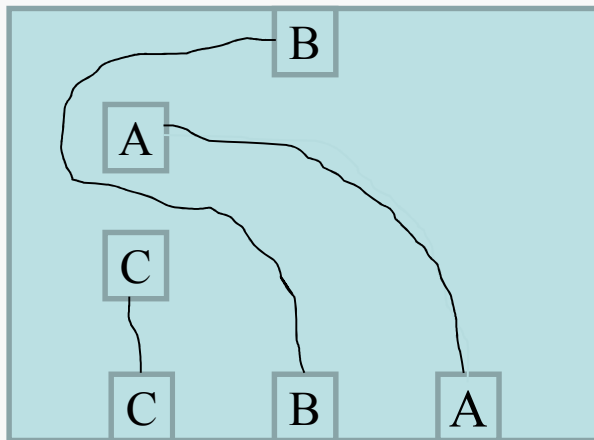
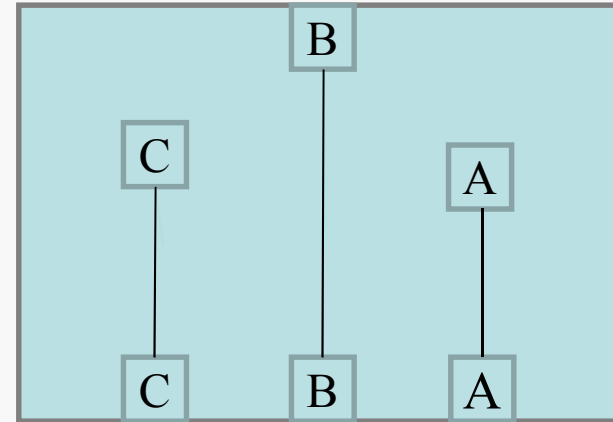
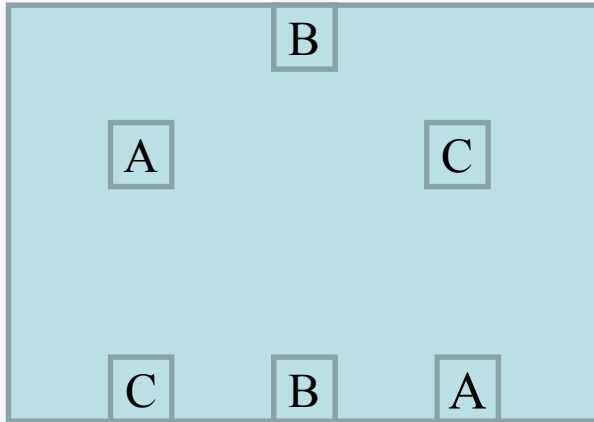

Some problems can be viewed as moving from a start state to a goal state via a series of steps.

If you can determine some intermediate step (I) on the path from start to goal, that simplifies the problem:

Move from Start to I

Move from I to Goal

# Easy Yellow-out Puzzle

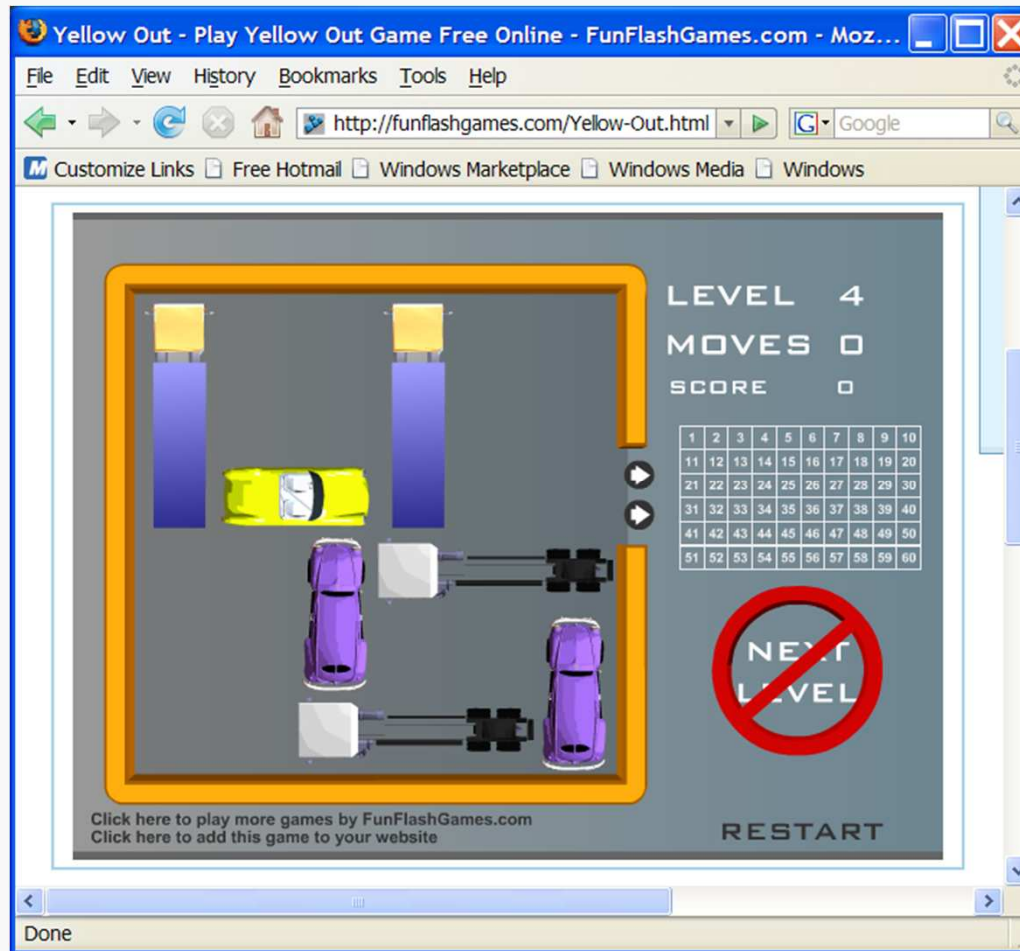

# Harder Yellow-out Puzzle

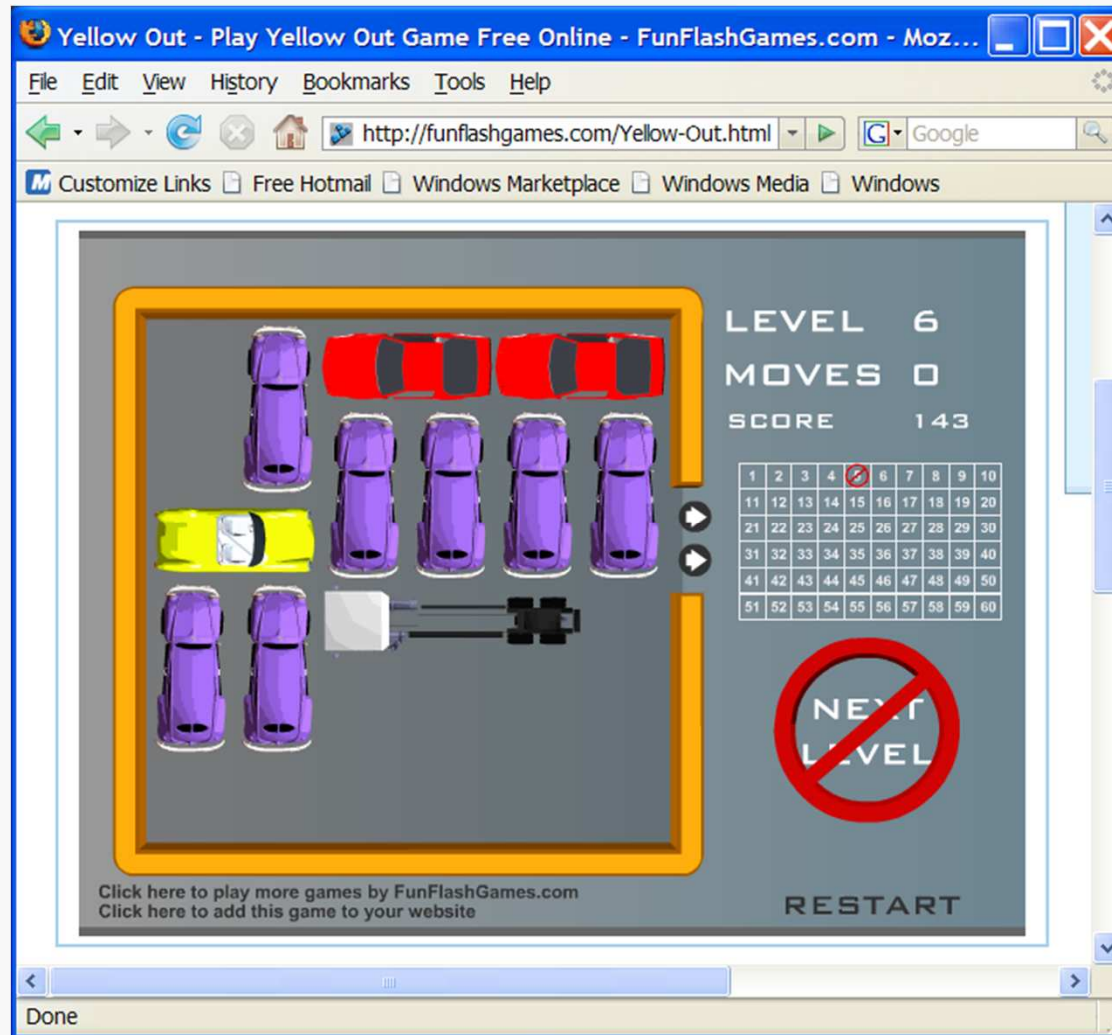

# Even Harder Yellow-out Puzzle

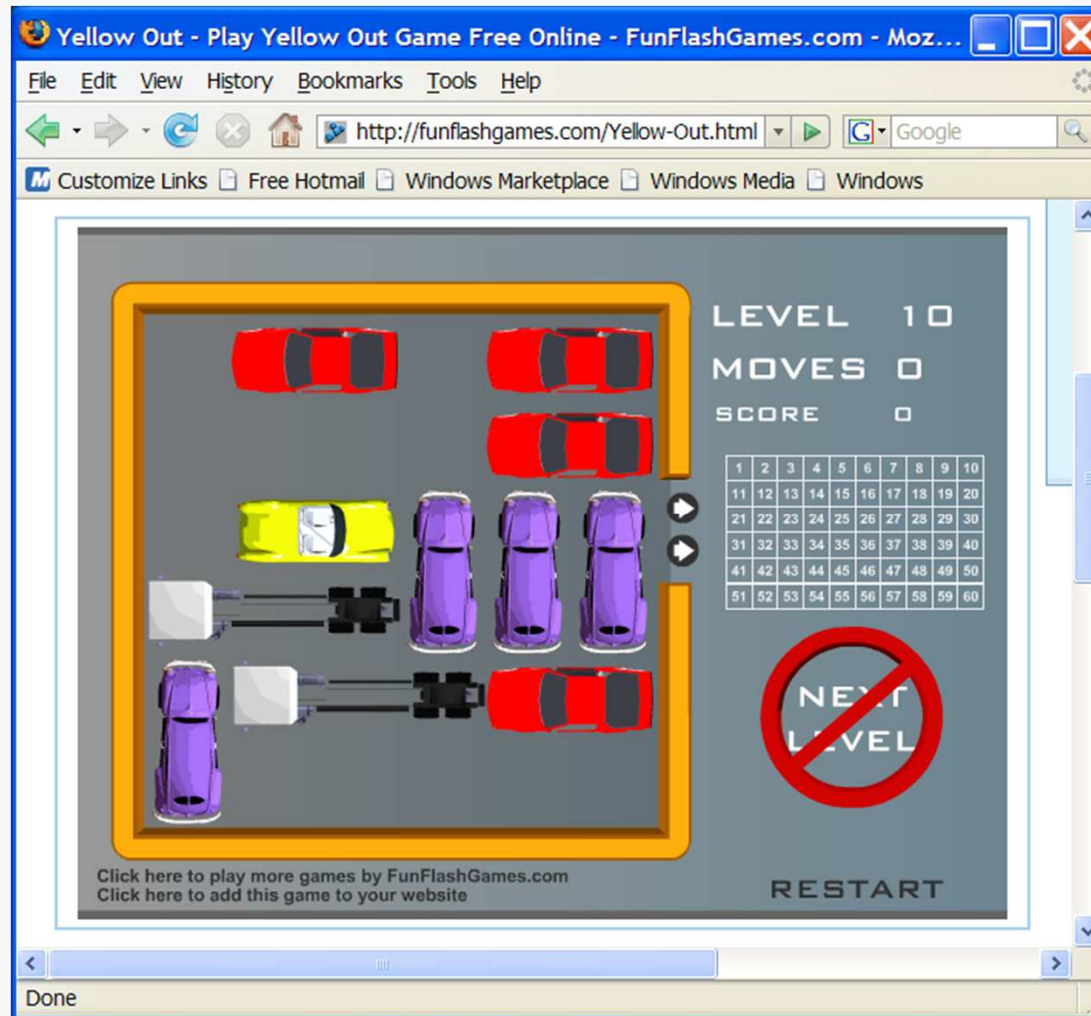



Move one disk at a time

No disk can sit on a smaller disk

Get all disks from pole 1 to pole 3

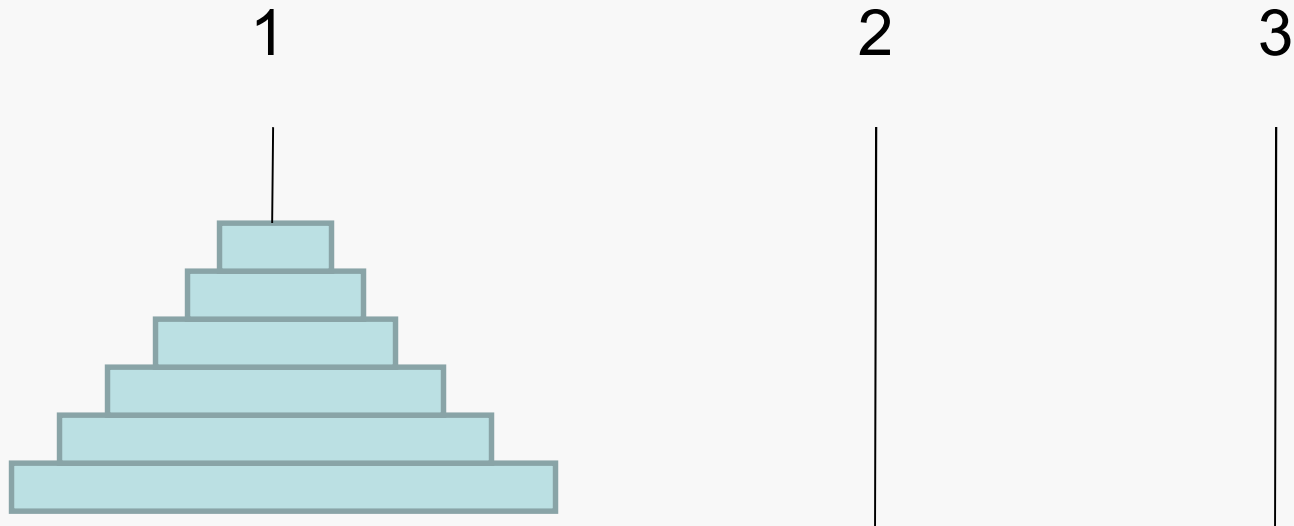

A monk climbs a mountain. He starts from the bottom at 8 AM and reaches the top at noon. He spends the rest of the day there. The next day, he leaves at 8 AM and goes back to the bottom along the same path.

Prove that there is a time between 8 AM and noon on each day that he is in the same place, at the same time, on both days.

Stuck? Try drawing a picture.

If you find a symmetry, you might be able to exploit it

Symmetries give you “free” information, cut down on what to look at

Symmetries define an invariant

Symmetries indicate “special” points

# Square Within a Square

What is the ratio of the areas of the two squares?

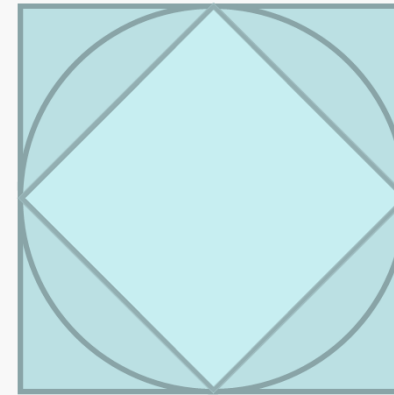
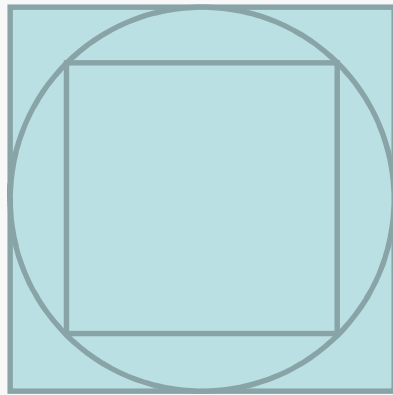

Your cabin is two miles due north of a stream that runs east-west. Your grandmother's cabin is located 12 miles west and one mile north of your cabin. Every day, you go from your cabin to Grandma's, but first visit the stream (to get fresh water for Grandma).

What is the length of the route with minimum distance?

Stuck? Draw a picture!

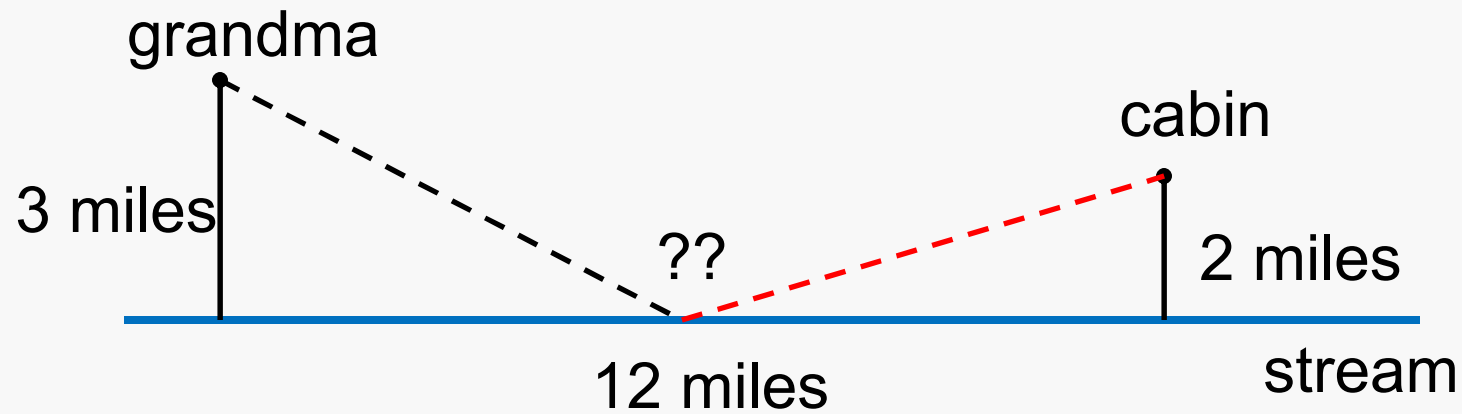

# To Grandma's Cabin

Draw a better picture!

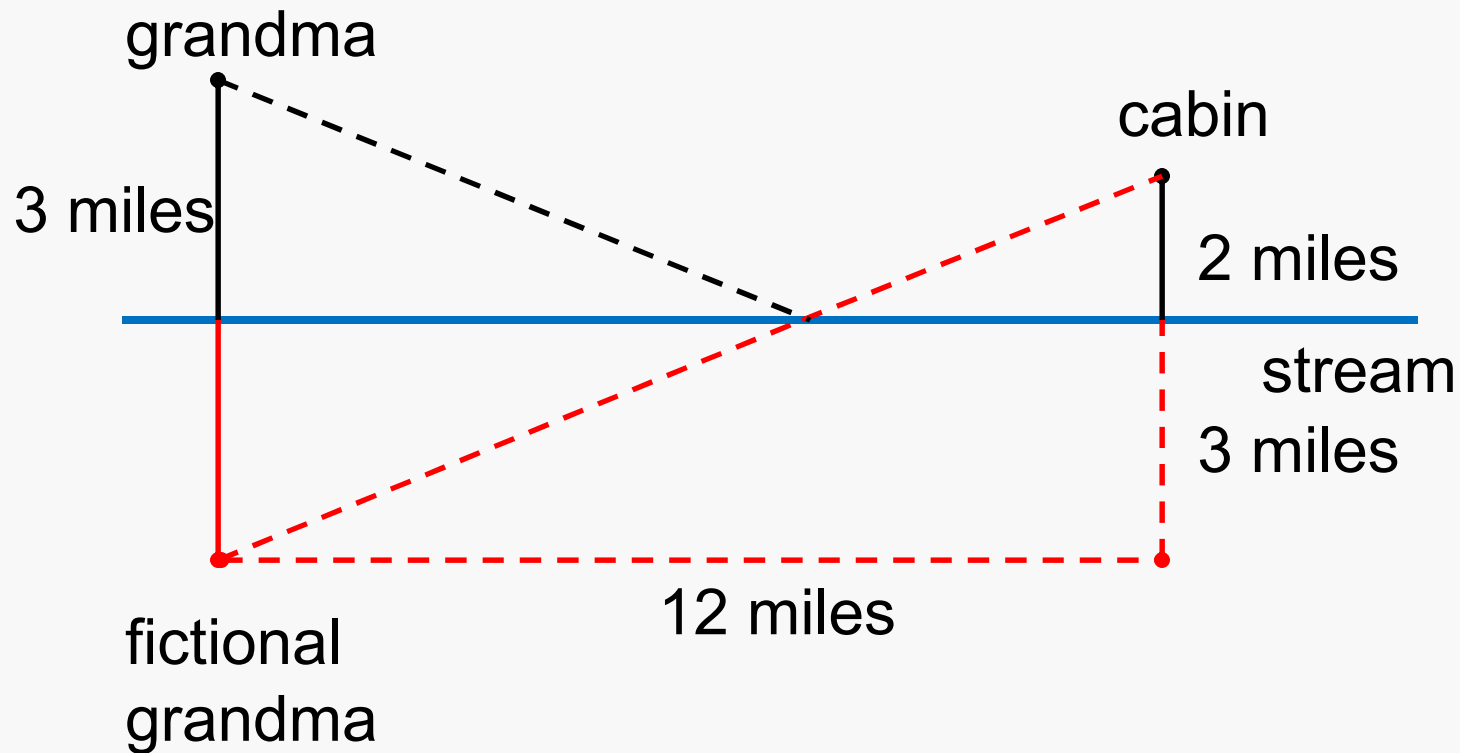

Got it now?

What is the sum of the values 1 to 100?

Hint: Look for the symmetry!



If you have more pigeons than pigeonholes, when the pigeons fly into the holes at night, at least one hole has more than one pigeon.

Problem:

Every point on the plane is colored either red or blue. Prove that no matter how the coloring is done, there must exist two points, exactly a mile apart, that are the same color.

Given a unit square, show that if five points are placed anywhere inside or on this square, then two of them must be at most  $\sqrt{2}/2$  units apart.

If you have  $N$  pigeons and  $M$  pigeonholes, when the pigeons fly into the holes at night:

- at least one pigeonhole must contain at least  $\lceil N / M \rceil$  pigeons
- at least one pigeonhole must contain no more than  $\lfloor N / M \rfloor$  pigeons

An invariant is some aspect of a problem that does not change.

Similar to symmetry

Often a problem is easier to solve when you focus on the invariants

At first, a room is empty. Each minute, either one person enters or two people leave.

After exactly  $3^{1999}$  minutes, could the room contain  $3^{1000} + 2$  people?

If 127 people play in a singles tennis tournament, prove that at the end of the tournament, the number of people who have played an odd number of games is even.

Situation: stale cereal in stores.

Perceived problem: streamline the production process to get cereal to store shelves faster.

1. Get cereal to market faster.
  1. Build plants closer to market.
  2. Improve transportation.
    1. Hire faster trucks and race car drivers.
    2. Ignore speed limits.
    3. Use jet planes.

1. Make it OK for cereal NOT to get to market faster.
  1. Stop making cereal.
  2. Make cereal stay fresher longer:
    1. add chemical to slow spoiling,
    2. make better boxes.
  3. Convince customers that stale cereal is OK.



Original: Cereal is clearly not getting to market fast enough to retain freshness.

1. Read the sentence with emphasis on each of these words – what questions do they suggest?
  - Cereal
  - Getting
  - Market
  - Freshness

Original: Cereal is clearly not getting to market fast enough to retain freshness.

2. Pick a term with a definition and replace the term with the definition, e.g.,
  - cereal -> breakfast food that comes in box,
  - market -> the place where it is sold,
  - retain freshness -> without getting stale.
- The change in emphasis makes us think about how we might change the box to prevent staleness, rather than thinking about speeding to market.

Original: Cereal is clearly not getting to market fast enough to retain freshness.

3. Reverse: How can we make cereal get to market so slowly that it is never fresh?
  - This makes us think about how long we must retain freshness, and what controls it.

Original: Cereal is clearly not getting to market fast enough to retain freshness

4. Change “every” to “some,” “always” to “sometimes,” etc.
  - Cereal **sometimes** is not getting to market fast enough to retain freshness.
  - Makes one think about things like why it is not **always** fresh, is it OK to occasionally not be fresh, etc.

Original: Cereal is clearly not getting to market fast enough to retain freshness.

5. Challenge assumptions.

- “Clearly” suggests an assumption.
- Maybe cereal doesn’t get to store already stale?
- Maybe the store holds it too long.
- Maybe it is stale before it leaves the factory.

Original: Cereal is clearly not getting to market fast enough to retain freshness.

6. Freshness is inversely proportional to the time since the cereal is baked:  
freshness =  $K/\text{time}$  .

- Can we change K, the constant of proportionality? What does that depend on?
- Packaging? Storage conditions? Type of cereal?
- Change time? At factory? During shipping? Time to shelve? Shelf time?