

heuristic (adj)

- involving or serving as an aid to learning, discovery, or problem-solving by experimental and especially trial-and-error methods;
- of or relating to exploratory problem-solving techniques that utilize self-educating techniques (as the evaluation of feedback) to improve performance

heuristic (noun)

- the study or practice of heuristic procedure
- a heuristic method or procedure

www.merriam-webster.com

For some problems, you can get to a solution by:

- Solving a simpler form (wishful thinking: that the problem were simpler)
- Modifying the solution for the simpler form to become a solution for the original form

Wishful Thinking Example

Draw a continuous line connecting each pair of boxes that have the same label.

The lines cannot go outside the large box, go through the small boxes, and they cannot cross.

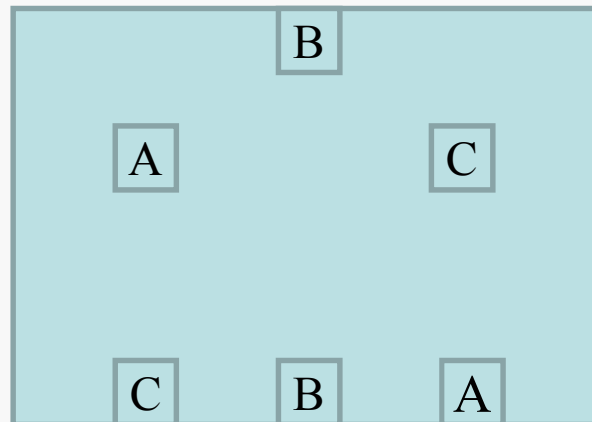

Wishful Thinking Example

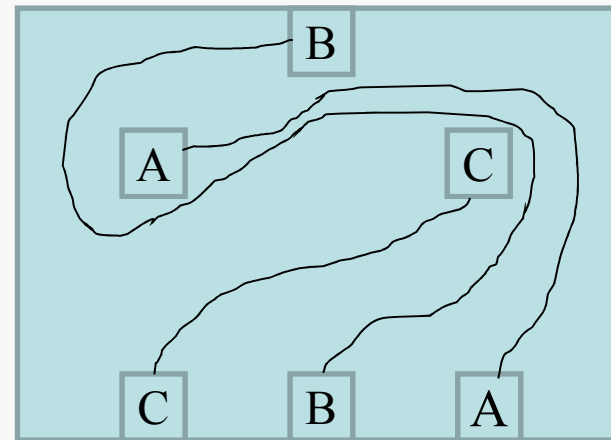
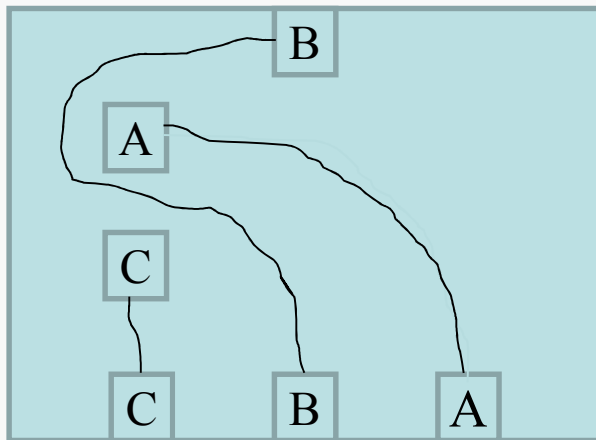
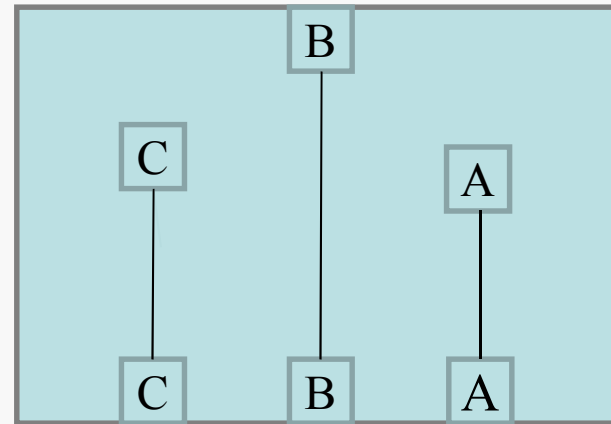
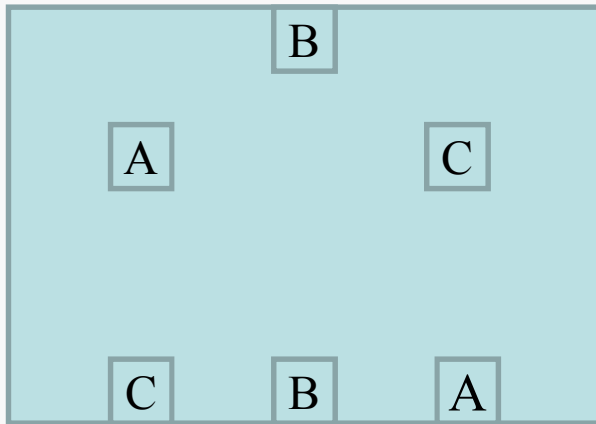

Some problems can be viewed as moving from a start state to a goal state via a series of steps.

If you can determine some intermediate step (I) on the path from start to goal, that simplifies the problem:

Move from Start to I

Move from I to Goal

Easy Yellow-out Puzzle

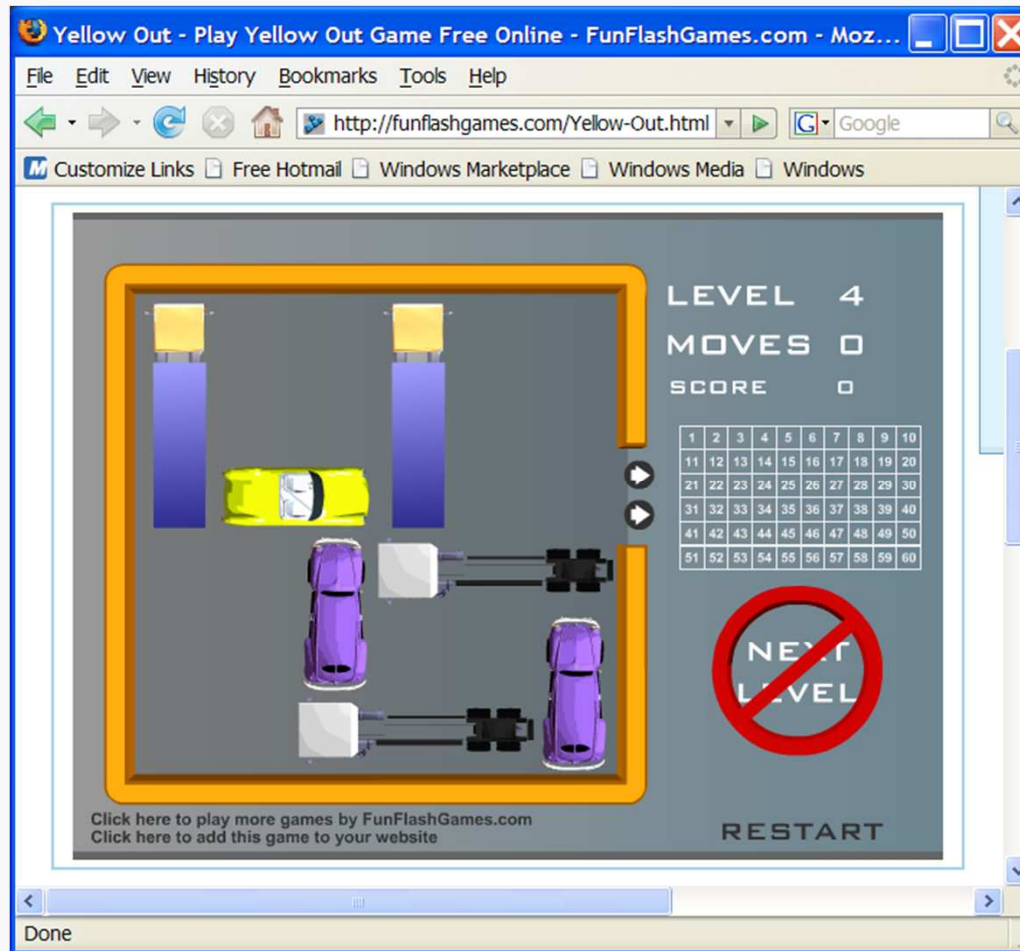

Harder Yellow-out Puzzle

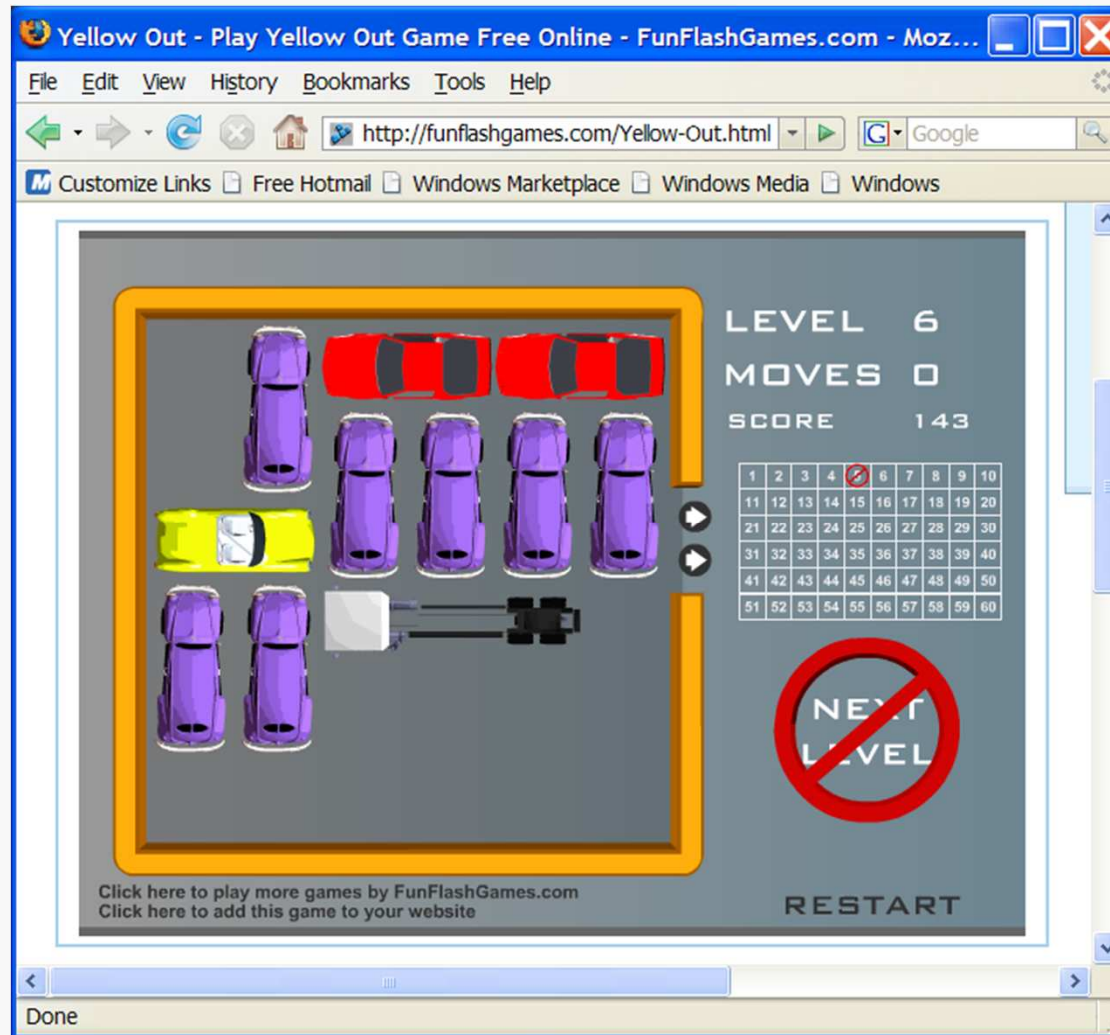

Even Harder Yellow-out Puzzle

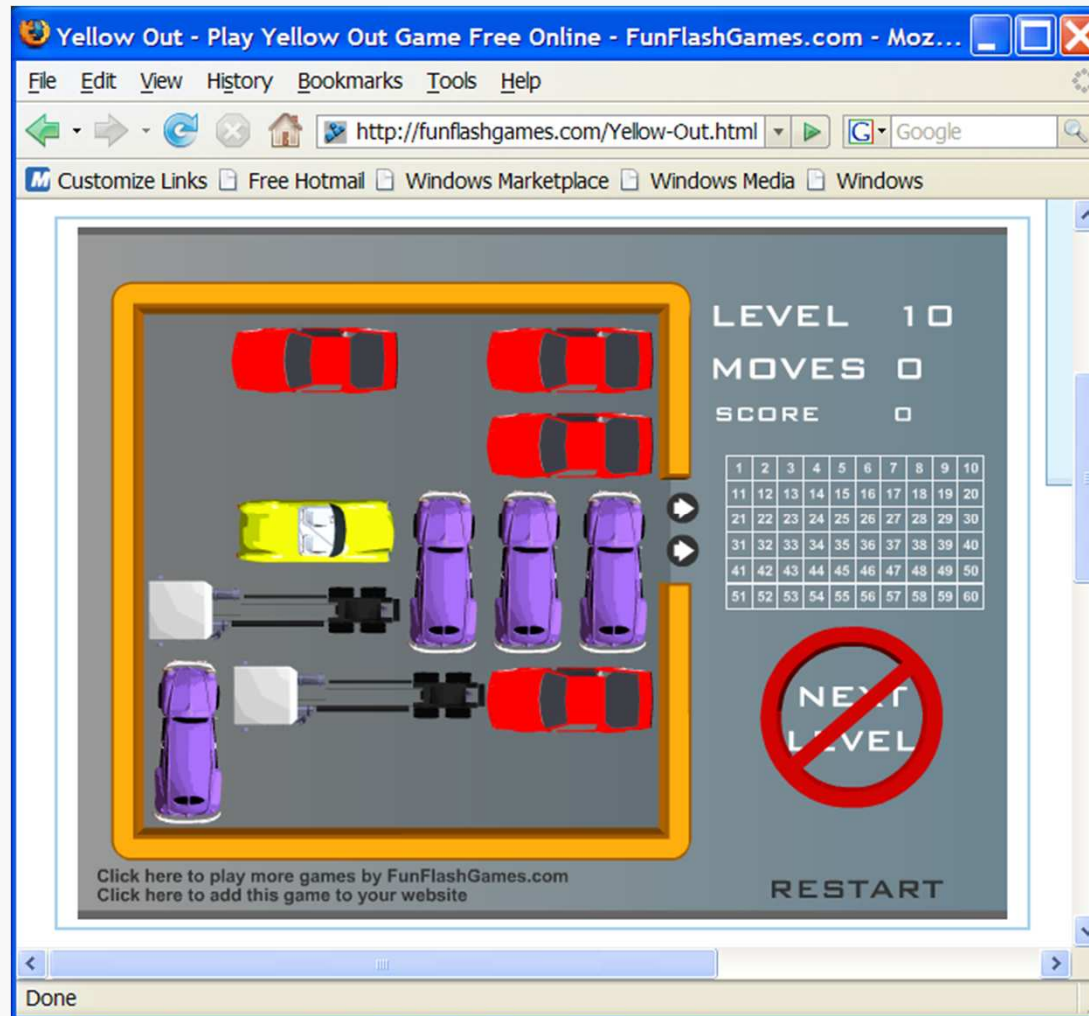

Move one disk at a time

No disk can sit on a smaller disk

Get all disks from pole 1 to pole 3

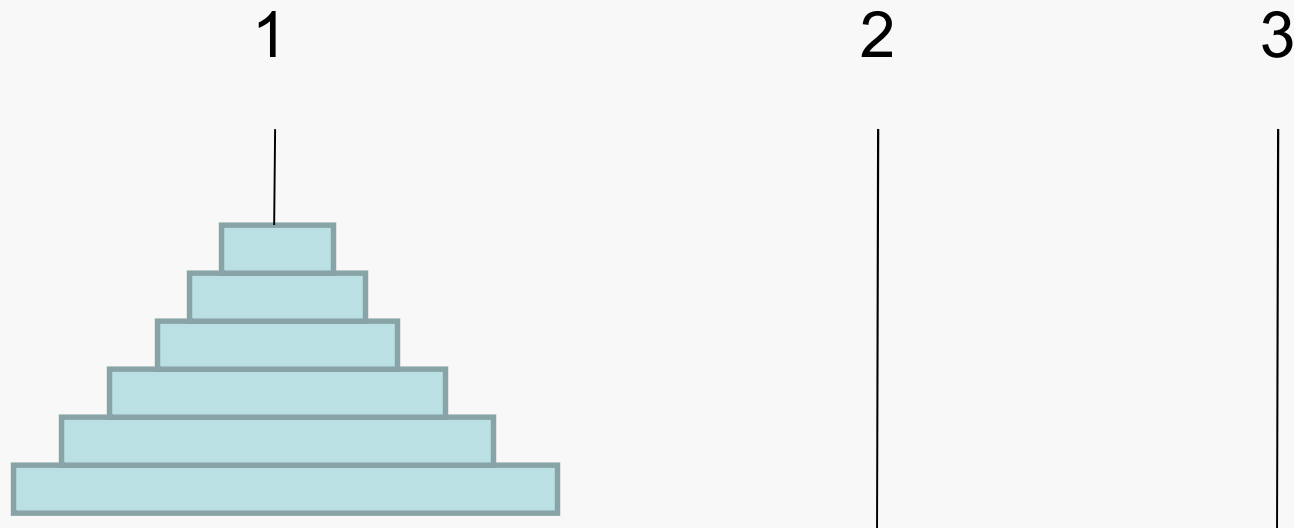

A monk climbs a mountain. He starts from the bottom at 8 AM and reaches the top at noon. He spends the rest of the day there. The next day, he leaves at 8 AM and goes back to the bottom along the same path.

Prove that there is a time between 8 AM and noon on each day that he is in the same place, at the same time, on both days.

Stuck? Try drawing a picture.

If you find a symmetry, you might be able to exploit it

Symmetries give you “free” information, cut down on what to look at

Symmetries define an invariant

Symmetries indicate “special” points

Square Within a Square

What is the ratio of the areas of the two squares?

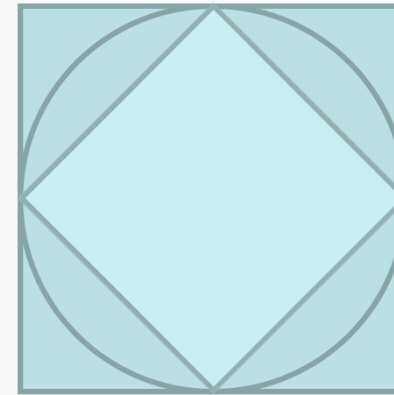
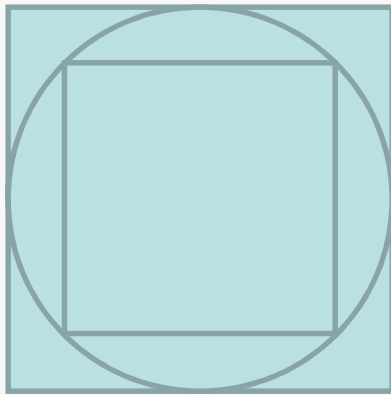

Your cabin is two miles due north of a stream that runs east-west. Your grandmother's cabin is located 12 miles west and one mile north of your cabin. Every day, you go from your cabin to Grandma's, but first visit the stream (to get fresh water for Grandma).

What is the length of the route with minimum distance?

Stuck? Draw a picture!

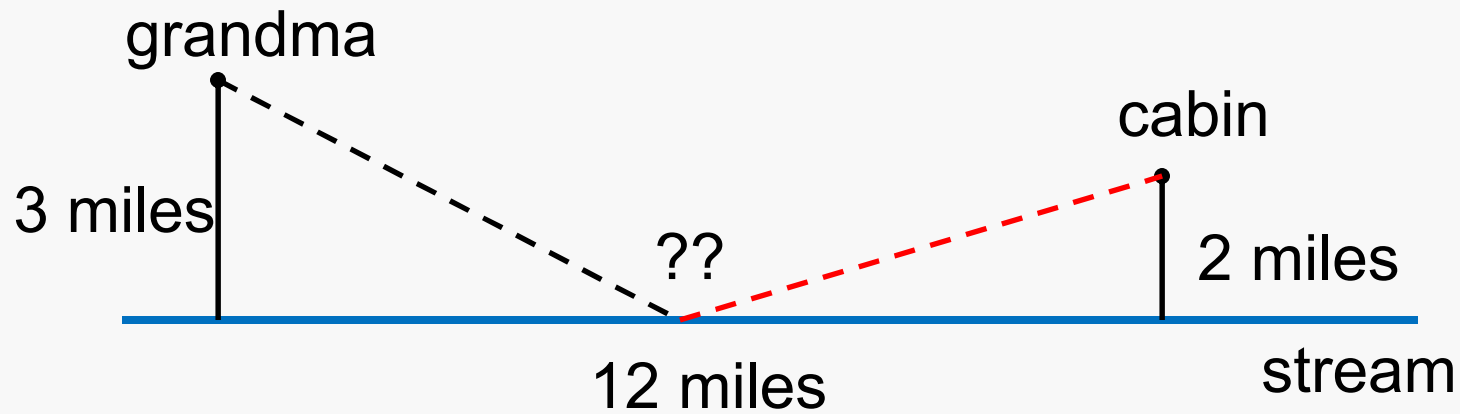

Draw a better picture!

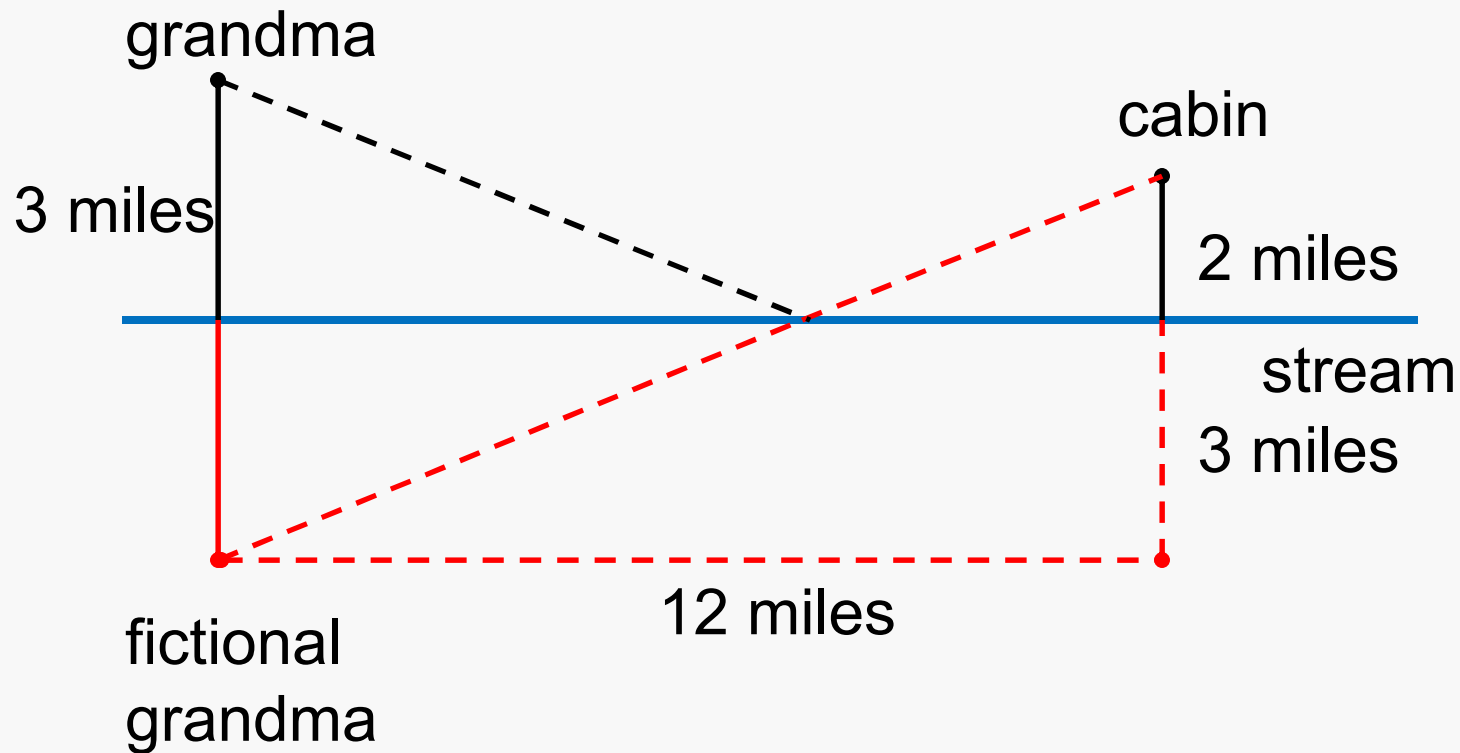

Got it now?

What is the sum of the values 1 to 100?

Hint: Look for the symmetry!

If you have more pigeons than pigeonholes, when the pigeons fly into the holes at night, at least one hole has more than one pigeon.

Problem:

Every point on the plane is colored either red or blue. Prove that no matter how the coloring is done, there must exist two points, exactly a mile apart, that are the same color.

Given a unit square, show that if five points are placed anywhere inside or on this square, then two of them must be at most $\sqrt{2}/2$ units apart.

An invariant is some aspect of a problem that does not change.

Similar to symmetry

Often a problem is easier to solve when you focus on the invariants

Three women check into a hotel room with a rate of \$27/night. They each give \$10 to the porter, and ask her to bring back three dollars. The porter learns that the room is actually \$25/night. She gives \$25 to the desk clerk, and gives the guests \$1 each without telling them the true rate. Thus the porter has kept \$2, while each guest has spent $\$10 - \$1 = \$9$, a total of $2 + 3 \times 9 = \$29$.

What happened to the other dollar?

At first, a room is empty. Each minute, either one person enters or two people leave.

After exactly 3^{1999} minutes, could the room contain $3^{1000} + 2$ people?

If 127 people play in a singles tennis tournament, prove that at the end of the tournament, the number of people who have played an odd number of games is even.